

VARESE

Nickel matt oder Messing matt, Stoffschirm ·
nickel mat or brass mat, fabric shade ·
nickel mat ou laiton mat, abat-jour tissu ·
nikkel mat of messing mat, Stoffen kap ·
níquel mate o bronze mate, Pantalla de tela ·
nichel opaco o ottone satinato, paralume in tessuto ·
nichel mat sau bronz mat, abajur textil ·
harjattu teräs tai mattamessinki, kangas varjostin ·
nikiel mat lub mosiądz mat, Klosz z materiału ·
mat nikel veya mat piring, Kumaş şapka



Sensordimmer · Sensor dimmer ·
Variateur tactile · Touchdimmer ·
Regulador con sensor · Touchdimmer ·
Variator cu senzor · Kosketushimmennin ·
Czujnik ściemniania · El dimeri





07



schwenkbar · tiltable ·
pivotant · draaibaar ·
pivotante · girevole ·
pivotant · suunnattava ·
skrętny · eġilebilir

500



Dimmen und Lichtfarbe einstellen ·
Dimming and adjusting light color ·
Varier et choisir la couleur de la lumière ·
Dimmen en lichtkleur instellen ·
Atenuación y ajuste del color de la luz ·
Variare e scegliere il colore della luce ·
Variati lumina si ajustati culoarea luminii ·
Himmennys ja värilämpötilan säätö vakiokytkimellä ·
ściemniać i jasność ustawić ·
Işıġı kısmak ve rengini ayarlamak





08

QUEBEC

Nickel matt oder Messing matt · nickel mat or brass mat ·
nickel mat ou laiton mat · nikkell mat of messing mat ·
níquel mate o bronze mate · nichel opaco o ottone satinato ·
nichel mat sau bronz mat · harjattu teräs tai mattamessinki ·
nikiel mat lub mosiądz mat · mat nikel veya mat piring



501



↑ 180 cm, ↗ 50 cm
incl. SMD-LED, 34 W
3.000 lm, 3.000 - 6.000 K
incl. SMD-LED, 5,5 W
400 lm, 3.000 - 6.000 K



422710307
422710308

07 Nickel matt · nickel mat
08 Messing matt · brass mat

SPLIT

Nickel matt · nickel mat ·
nickel mat · nikkell mat · níquel mate ·
nichel opaco · nichel mat · harjattu teräs ·
nikiel mat · mat nikel



502



↑ 180 cm, √ 43 cm
incl. SMD-LED, 20 W
2.000 lm, 3.000 - 5.500 K
incl. 1 x SMD-LED, 3,5 W
340 lm, 3.000 - 5.500 K



424910207

Stufenlos dimmbar, Lichtfarbe stufenlos einstellbar ·
infinitely dimmable, light color infinitely variable ·
infiniment dimmable, couleur de lumière infiniment
variable · traploos dimbaar, lichtkleur traploos
instelbaar · sin etapas regulable, color de luz
infinitamente variable · infinitamente dimmerabile,
colore della luce infinitamente variabile ·
variator de lumina fara trepte, cu intrerupator
standard de lumina · portaaton himmennys,
valon väri portaattomasti · bezstopniowe
ściemnianie, jasny kolor bezstopniowo ·
fasilasız dim ayarı, açık renk sonsuz deęişken





PILLAR

chrom, Acryl · chrome, acryl ·
chrome, acryl · chroom, acryl · cromo, acrílico ·
cromo, acrílico · crom, acrílic · kromi, akryyli ·
chrom, akryl · krom, akrilik



↑ 150 cm, Ø 24 cm
incl. 1 x SMD-LED, 24 W
max. 2.000 lm, 3.000 K



423510101



SANTO II

Metall, Glas alabasterfarbig ·
 metal, alabaster-coloured glass ·
 metale, verre couleur albâtre ·
 metaal, albastkleurig glas ·
 metal, vidrio de color alabastro ·
 metallo, vetro colore alabastro ·
 metal, sticla culoare alabastru ·
 metalli, lasi alabasteri väri ·
 metal, szkło alabaster kolor ·
 metal, cam kaymaktaşı rengi



ARIZONA

Nickel matt oder Messing matt ·
 nickel mat or brass mat ·
 nickel mat ou laiton mat ·
 nikkell mat of messing mat ·
 níquel mate o bronce mate ·
 nichel opaco o ottone satinato ·
 nichel mat sau bronz mat ·
 harjattu teräs tai mattamessinki ·
 nikiel mat lub mosiądz mat ·
 mat nikel veya mat pirinç



08

504



↓ 180 cm, Ø 25,5 cm, ↗ 40 cm
 incl. 4 x SMD-LED, 4,5 W, 4 x 400 lm, 3.000 K
 incl. 1 x SMD-LED, 4,5 W, 400 lm, 3.000 K

↓ 180 cm, Ø 25,5 cm, ↗ 40 cm
 incl. SMD-LED, 20 W, 1.650 lm, 3.000 K
 incl. 1 x SMD-LED, 5 W, 460 lm, 3.000 K

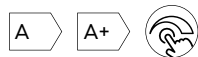

421910207
 421910228

426410207
 426410208

07 Nickel matt · nickel mat
 08 Messing matt · brass mat
 28 rostfarbig antik · antique rust



04

ARANGO

Nickel matt oder altmessing · nickel mat or old brass ·
nickel mat ou laiton fumé · nikkell mat of oud brons ·
níquel mate o bronce viejo · nichel opaco o ottone invecchiato ·
nichel mat sau bronz antic · harjattu teräs tai antiikkimessinki ·
nikiel mat lub patyna · mat nikel veyá antik piringç

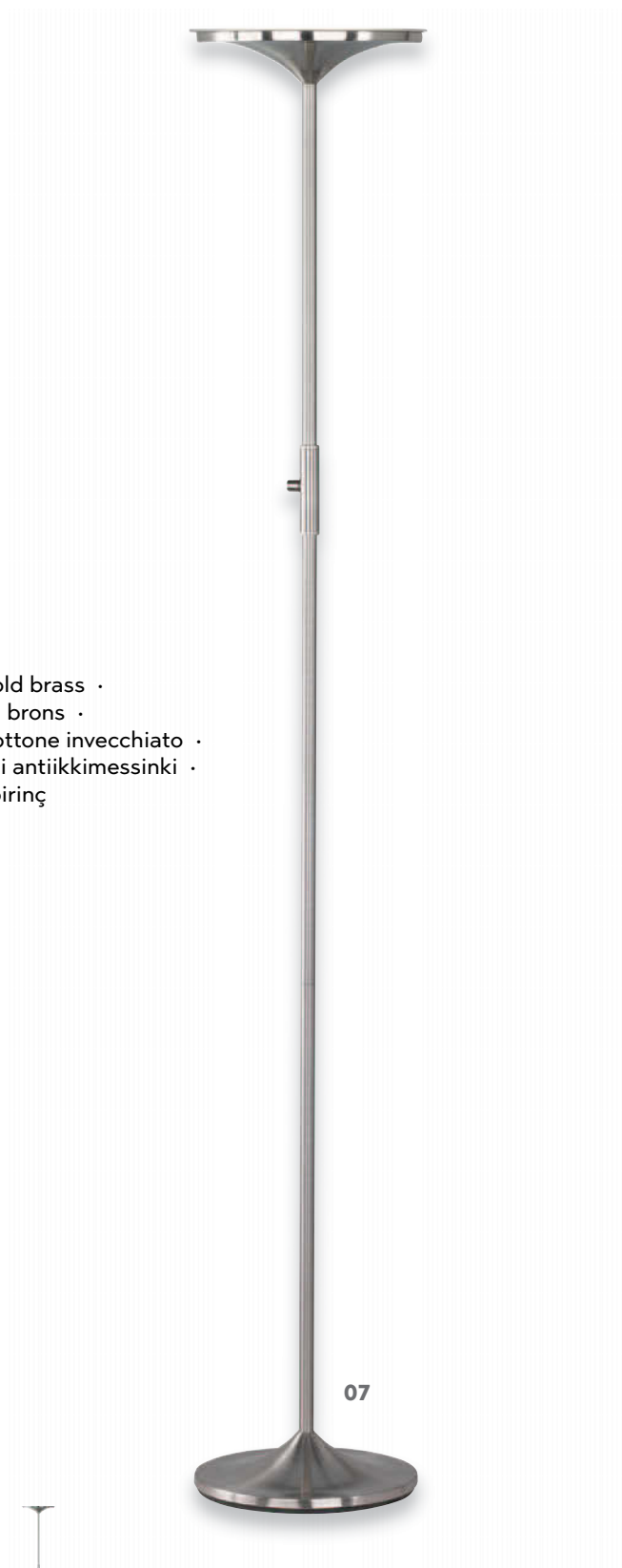

07



↓ 180 cm, Ø 31 cm
incl. 1 x SMD-LED, 20 W
1.750 lm, 3.000 K



429110104
429110107



04 altmessing · old brass
07 Nickel matt · nickel mat

BERGAMO

Nickel matt oder Messing matt · nickel mat or brass mat ·
 nickel mat ou laiton mat · nikkell mat of messing mat ·
 níquel mate o bronze mate · nichel opaco o ottone satinato ·
 nichel mat sau bronz mat · harjattu teräs tai mattamessinki ·
 nikiel mat lub mosiądz mat · mat nikel veya mat piring



Sensordimmer · Sensor dimmer ·
 Variateur tactile · Touchdimmer ·
 Regulador con sensor · Touchdimmer ·
 Variator cu senzor · Kosketushimmennin ·
 Czujnik ściemniania · El dimeri

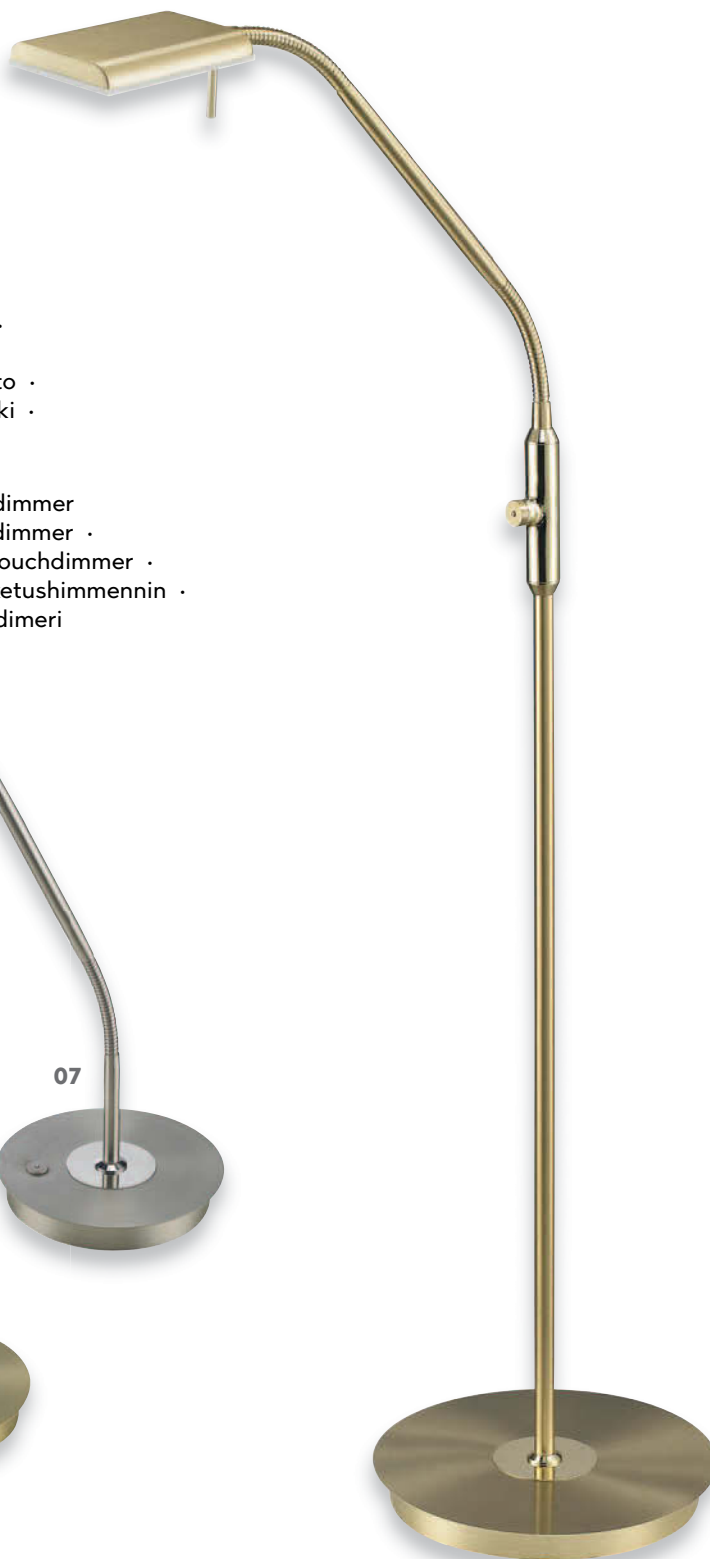

↑ 50 cm, ↗ 40 cm
 incl. 1 x SMD-LED, 12 W
 1.100 lm, 3.000 K



520910107
 520910108



↑ 135 cm, ↗ 50 cm
 incl. 1 x SMD-LED, 12 W
 1.100 lm, 3.000 K



420910107
 420910108



07 Nickel matt · nickel mat
08 Messing matt · brass mat

AURORA II

Nickel matt · nickel mat ·
nickel mat · nikkel mat · níquel mate · nichel opaco ·
nichel mat · harjattu teräs · nikiel mat · mat nikel



Sensordimmer · Sensor dimmer
Variateur tactile · Touchdimmer ·
Regulador con sensor · Touchdimmer ·
Variator cu senzor · Kosketushimmennin ·
Czujnik ściemniania · El dimeri



VERONA

Nickel matt · nickel mat ·
nickel mat · nikkel mat · níquel mate · nichel opaco ·
nichel mat · harjattu teräs · nikiel mat · mat nikel



Sensordimmer · Sensor dimmer
Variateur tactile · Touchdimmer ·
Regulador con sensor · Touchdimmer ·
Variator cu senzor · Kosketushimmennin ·
Czujnik ściemniania · El dimeri



↓ 130 cm, ↗ 70 cm
incl. 1 x SMD-LED, 12 W
1.100 lm, 3.000 K



420810107



↓ max. 153 cm, ↗ 70,5 cm
incl. 1 x SMD-LED, 8,8 W
950 lm, 3.000 K

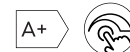

423710107



CALCIO

Nickel matt oder Messing matt · nickel mat or brass mat ·
nickel mat ou laiton mat · nikkel mat of messing mat ·
níquel mate o bronze mate · nichel opaco o ottone satinato ·
nichel mat sau bronz mat · harjattu teräs tai mattamessinki ·
nikiel mat lub mosiądz mat · mat nikel veya mat piring



08



07

508

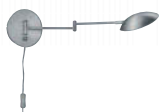

Ø 16 cm, √ max. 63 cm
incl. 1 x SMD-LED, 6 W
560 lm, 3.000 K



272470107
272470108



↓ 43 cm, √ 50 cm
incl. 1 x SMD-LED, 6 W
560 lm, 3.000 K



572410107
572410108



↓ 120 - 140 cm, √ max. 71 cm
incl. 1 x SMD-LED, 10 W
1.000 lm, 3.000 K



422410107
422410108



07 Nickel matt · nickel mat
08 Messing matt · brass mat

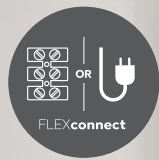

Seite/page 659

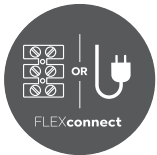
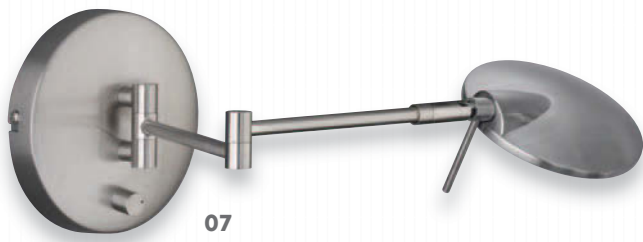

Seite/page 659



KAZAN

Nickel matt oder schwarz matt · nickel mat or black mat ·
 nickel mat ou noir mat · nikkell mat of mat zwart ·
 níquel mate o estera negra · nichel opaco o nero opaco ·
 nichel mat sau negru mat · harjattu teräs tai musta matto ·
 nikiel mat lub czarny mat · mat nikel veya siyah mat



Ø 14 cm, √ max. 55 cm
 incl. 1 x SMD, 8 W
 800 lm, 3.000 K



274770107
 274770132



↑ 46 cm, Ø 17 cm, √ max. 53 cm
 incl. 1 x SMD, 8 W
 800 lm, 3.000 K



574790107
 574790132



↑ 120 cm, Ø 24 cm, √ max. 61 cm
 incl. 1 x SMD, 8 W
 800 lm, 3.000 K



474790107
 474790132



07 Nickel matt · nickel mat
32 schwarz matt · black mat



32

PALO

Metall titanfarbig · metal titan ·
metale titane · metaal titaan · metal titán ·
metallo titano · metal titaniu · metalli titaani ·
metal tytanowy · metal titan



PALO II

Nickel matt · nickel mat ·
nickel mat · nikkell mat ·
níquel mate · nichel opaco ·
nichel mat · harjattu teräs ·
nikiel mat · mat nikel



↓ max. 40 cm, Ø 14 cm, ↗ 25 cm
incl. SMD-LED, 3 W
300 lm, 3.100 K



524510187



↓ 150 cm, Ø 20 cm, ↗ 40 cm
incl. SMD-LED, 5 W
480 lm, 3.100 K



424510187



↓ 150 cm, Ø 20 cm, ↗ 40 cm
incl. SMD-LED, 5 W
480 lm, 3.100 K



424590107

NARCOS

Nickel matt, weiß matt oder schwarz matt ·
nickel mat, white mat or black mat ·
nickel mat, blanc mat ou noir mat ·
nikkel mat, wit mat of mat zwart ·
níquel mate, estera blanca o estera negra ·
nichel opaco, bianco opaco o nero opaco ·
nichel mat, alb mat sau negru mat ·
harjattu teräs, valkoinen matto tai musta matto ·
nikiel mat, biały mat lub czarny mat ·
mat nikel, beyaz mat veya siyah mat

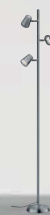

↑ 154 cm, ↔ 28 cm
incl. 3 x SMD-LED, 4,7 W
3 x 470 lm, 3.000 K

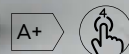

473190307
473190331
473190332



07 Nickel matt · nickel mat
31 weiß matt · white mat
32 schwarz matt · black mat



ZIDANE

Nickel matt · nickel mat ·
nickel mat · nikkell mat · níquel mate ·
nichel opaco · nichel mat · harjattu teräs ·
nikiel mat · mat nikel



↑ 145 cm, Ø 24 cm
incl. 3 x SMD-LED, 4,5 W
3 x 430 lm, 3.000 K



478610307



↑ 165 cm, 44 cm
excl. 1 x E27, max. 60 W



4035011-04
4035011-07
4035011-08



04 altmessing · old brass
07 Nickel matt · nickel mat
08 Messing matt · brass mat



ICARO

Metall, Glas matt · metal, mat glass ·
metale, verre mat · metaal, mat glas ·
metal, vidrio mate · metallo, vetro sabbato ·
metal, sticla mata · metalli, mattalasi ·
metal, szkło matowane · metal, mat cam



07



07



32

FILIGRAN

Nickel matt oder schwarz · nickel mat or black ·
nickel mat ou noir · nikkell mat of zwart ·
níquel mate o negro · nichel opaco o nero ·
nichel mat sau negru · harjattu teräs tai musta ·
nikiel mat lub czarny · mat nikel veya siyah



↓ 45 cm, ↗ 51 cm
incl. 1 x SMD-LED, 6 W
560 lm, 3.000 K



520490107



↓ 162 cm, ↗ 52 cm
incl. 1 x SMD-LED, 6 W
560 lm, 3.000 K



420490107
420490132



07 Nickel matt · nickel mat
32 schwarz matt · black mat



AMSTERDAM

Metall, weiß oder schwarz · metal, white or black ·
metale, blanc ou noir · metaal, wit of zwart ·
metal, blanco o negro · metallo, bianco o nero ·
metal, alb sau negru · metalli, valkoinen tai musta ·
metal, biały lub czarny · metal, beyaz veya siyah

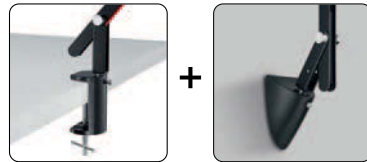

516



↑ max. 90 cm, ↗ max. 90 cm, Ø 18 cm
incl. 1 x COB-LED, 5 W
500 lm, 3.000 K



527920101
527920102



01 weiß · white
02 schwarz · black

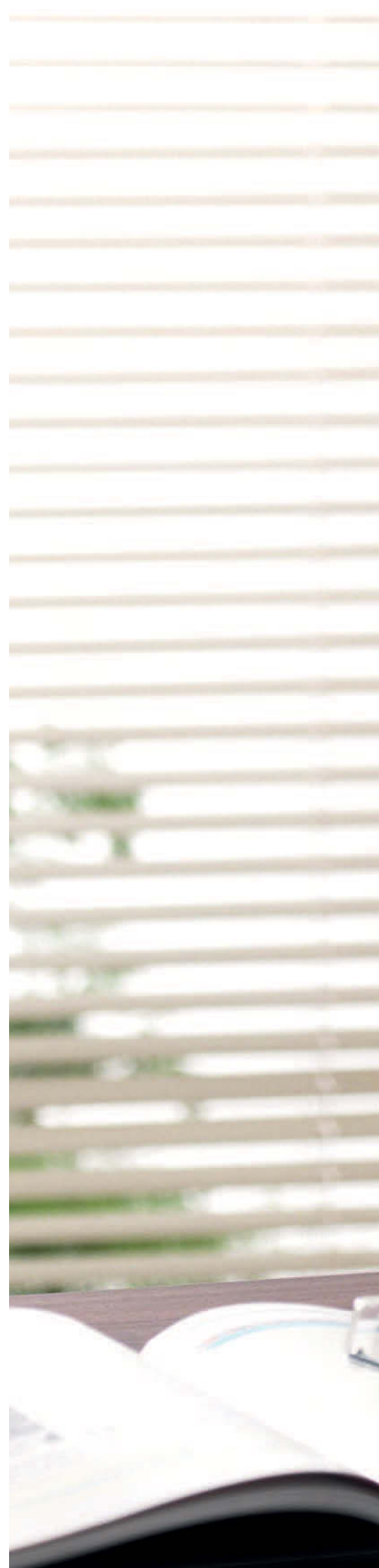





ROTTERDAM

Metall, Kunststoff, weiß oder anthrazit · metal, plastic, white or anthracite ·
metale, plastique, blanc ou anthracite · metaal, kunststof, wit of antraciet ·
metal, plástico, blanco o antracita · metallo, plastica, bianco o antracite ·
metal, plastic, alb sau antracit · metalli, muovi, valkoinen tai antrasiitti ·
metal, plastik, biały lub antracyt · metal, plastik, beyaz veya antrasit



518



↑ 38 cm, ↗ max. 53 cm, Ø 19 cm
incl. SMD-LED, 5 W
500 lm, 3.000 K



528020101
528020142



01 weiß · white
42 anthrazit · anthracite



RADO

Metall, Kunststoff · metal, plastic ·
metale, plastique · metaal, kunststof ·
metal, plástico · metallo, plastica · metal, plastic ·
metalli, muovi · metal, plastik · metal, plastik

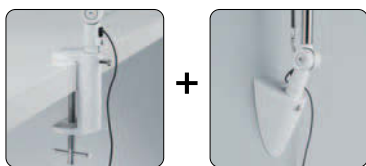

520



↑ 70 cm, ↗ 38 cm
incl. 1 x SMD-LED, 5 W
550 lm, 3.000 + 4.000 + 5.000 K



527690131
527690132

31 weiß matt · white mat
32 schwarz matt · black mat



RODERIC

Metall, Kunststoff · metal, plastic ·
metale, plastique · metaal, kunststof · metal, plástico ·
metallo, plastica · metal, plastic · metalli, muovi ·
metal, plastik · metal, plastik

521



↓ 60 cm, ↗ 55 cm
incl. 1 x SMD-LED, 6 W
670 lm, 3.000 K



527410101
527410142

01 weiß · white
42 anthrazit · anthracite



VARIO

Metall, Kunststoff · metal, plastic ·
metale, plastique · metaal, kunststof · metal, plástico ·
metallo, plastica · metal, plastic · metalli, muovi ·
metal, plastik · metal, plastik



87

02

522



↑ max. 64,5 cm, ↗ max. 50 cm
incl. SMD-LED, 3,6 W
200 lm, 3.000 K



522520101
522520102
522520187

01 weiß · white
02 schwarz · black
87 titanfarbig · titanium-coloured



GRANDE

Kunststoff · plastic ·
 plastique · kunststof · plástico · plastica ·
 plastic · muovi · plastik · plastik



USB Anschluss mit Ladefunktion · Recharging USB connection ·
 Entrée USB de rechargement · Opladende USB
 aansluiting · Conexión USB de recarga · Connessione
 USB di ricarica · Conexiune USB reîncărcare · Lataaminen
 USB-liitäntä · ładowania USB połączenie · şarj USB baġlantı



↓ 62 cm, ↗ 40 cm
 incl. 1 x SMD-LED, 9 W
 1.300 lm, 3.000 + 4.000 + 5.000 K

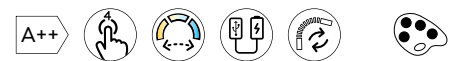

525690101
 525690111

01 weiß · white
 11 grau · grey



POLO

Kunststoff · plastic ·
 plastique · kunststof · plástico ·
 plastica · plastic · muovi ·
 plastik · plastik



SWAN

Aluminium, Kunststoff · aluminium, plastic ·
 aluminium, plastique · aluminium, kunststof ·
 aluminio, plástico · alluminio, plastica ·
 aluminiu, plastic · alumiini, muovi ·
 aluminium, plastik · alüminyum, plastik



↓ 41 cm, ↗ 40 cm
 incl. 1 x SMD-LED, 5 W
 550 lm, 3.000 + 4.000 + 5.000 K



527090111
 527090131



↓ 50 cm, ↔ 16 cm, ↗ 45 cm
 incl. 1 x SMD-LED, 7 W
 470 lm, 2.500 - 4.000 K



523910101
 523910102



01 weiß · white
02 schwarz · black
11 grau · grey
31 weiß matt · white mat

LORIS

Kunststoff, titanfarbig · plastic, titan ·
plastique, titane · kunststof, titaan ·
plástico, titán · plastica, titano ·
plastic, titaniu · muovi, titaani ·
plastik, tytanowy · plastik, titan



525

↑ 45 cm, ↔ 12 cm, ↗ 47
incl. 1 x SMD-LED, 5,5 W
500 lm, 3.000 + 5.000 K



526290187

PRETO

Metall, Kunststoff · metal, plastic ·
 metale, plastique · metaal, kunststof ·
 metal, plástico · metallo, plastica ·
 metal, plastic · metalli, muovi ·
 metal, plastik · metal, plastik



CURTIS

altmessing, Nickel matt oder Messing matt ·
 old brass, nickel mat or brass mat ·
 laiton fumé, nickel mat ou laiton mat · oud brons,
 nikkel mat of messing mat · bronce viejo, níquel mate
 o bronce mate · ottone invecchiato, nichel opaco o
 ottone satinato · bronz antic, nichel mat sau bronz mat ·
 antiikkimessinki, harjattu teräs tai mattamessinki ·
 patyna, nikiel mat lubmosiądz mat ·
 antik piring, mat nikel veya mat piring



↑ max. 40 cm, ↗ 25 cm
 incl. SMD, 3,8 W
 350 lm, 3.100 K



528310107



↑ max. 40 cm, ↗ 40 cm
 incl. SMD, 3,8 W
 350 lm, 3.100 K



528380107



↑ 35 cm, ↗ max. 18,5 cm
 incl. SMD-LED, 4 W
 380 lm, 3.000 K



579790104
 579790107
 579790108



04 altmessing · old brass
 07 Nickel matt · nickel mat
 08 Messing matt · brass mat



POLLY

Kunststoff · plastic ·
 plastique · kunststof ·
 plástico · plastica ·
 plastic · muovi ·
 plastik · plastik



KOLIBRI

Metall, Kunststoff · metal, plastic ·
 metale, plastique · metaal, kunststof · metal, plástico ·
 metallo, plastica · metal, plastic · metalli, muovi ·
 metal, plastik · metal, plastik



↑ 35 cm, ↗ 32 cm
 incl. 1 x SMD, 4,4 W
 450 lm, 3.000 K



527810101
 527810107
 527810115



↑ 40 cm, ↔ 16 x 16 cm, ↗ 39 cm
 incl. 1 x SMD, 4,8 W
 450 lm, 3.000 K



573910101
 573910106



01 weiß · white
06 chrom · chrome
07 Nickel matt · nickel mat
15 grün · green



01



02

LUPO

Kunststoff · plastic ·
 plastique · kunststof · plástico ·
 plastica · plastic · muovi · plastik · plastik



↑ 35 cm, Ø 13,5 cm, √ 30 cm
 incl. 1 x SMD-LED, 5 W
 550 lm, 3.500 K



527290101
 527290102



↑ 35 cm, Ø 13,5 cm, √ 30 cm
 incl. 1 x SMD-LED, 5 W
 550 lm, 3.500 K



227280101
 227280102



01 weiß · white
 02 schwarz · black

Formeln der geometrischen Optik
den Vergleich ähnlicher
Abbildungsvhältnisse der geometrischen
Grundformeln der geometrischen
Abbildungsgleichung

OP und MO'P' ähn
O und O' rech
M gleiche
folgende

Der Abb
Verhältnis de
der Bildvergrößer
stand, in welchem Ver
and auf der Filmebene

Definitionsgemäss ist der Abbildungs
massstab das Verhältnis zwischen
der Abbildung und der Grösse
des Gegenstandes. Ein Massstab von 1:1
würde gleich gross abgebildet
zu fotografierende Gegenstände
massstab 1:2 hingegen nur halb
Abbildung nur halb so gross
Bild sei doppelt so gross
dargestellt.

Genau gleich
Massstab
genau
Land-

Praxis wissen
wir, dass ein Gegenstand um so grösser
abgebildet wird, je kleiner die Aufnahme-
medistanz (Dingweite) oder - bei gleich-
bleibender Aufnahme- medistanz - je länger
die Objektivbrennweite ist. Wenn wir
mit einem Vario-Objektiv bei gleichblei-

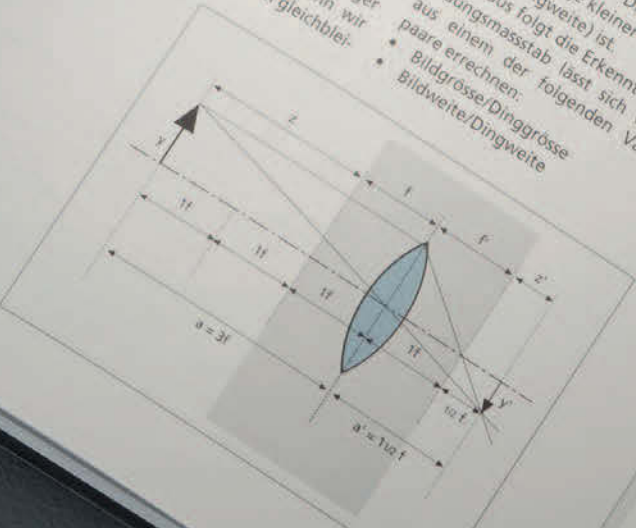

Der Abbildungs-
massstab (m = 1:2)

... bilden
das kleinere Glied
1. Zwar weniger bil
rechnerische Zwer
erlaubt, ist die
massstabes al

Aufnahmestandpunkt ein Ob-
eranholen), machen wir nichts
als die Brennweite verlängern
bei den Bildausschnitt ver-
m. Weil der Bildmassstab ver-
grössert dabei gleich bleibt,
nehmen wir lediglich einen Ausschnitt
des grösseren Bildes.
Der Abbildungs-
massstab hängt sowohl von der Aufnahme-
medistanz als auch von der Objektiv-
brennweite ab.
Aus Erfahrung und aus den bisher-
gen Betrachtungen wissen wir, dass der
Kameraauszug (die Bildweite) gleich
gross ist wie die Brennweite, wenn sich
der Aufnahmegegenstand unendlich
weit weg befindet. Die Bildweite wird
um so grösser, je kleiner die Aufnahme-
medistanz (Dingweite) ist.
Daraus folgt die Erkenntnis: Der Ab-
bildungsmassstab lässt sich wahlweise
aus einem der folgenden Variablen-
paare errechnen:
• Bildgrösse/Dinggrösse
• Bildweite/Dingweite



32

KIMI

Metall, Holz · metal, wood ·
metale, bois · metaal, hout · metal, madera · metallo, di legno ·
metal, lemn · metalli, puu · metal, drewno · metal, tahta



↑ max. 50 cm, Ø 16 cm, ↗ max. 37,5 cm
excl. 1 x E27, max. 40 W



508300131
508300132



31 weiß matt · white mat
32 schwarz matt · black mat

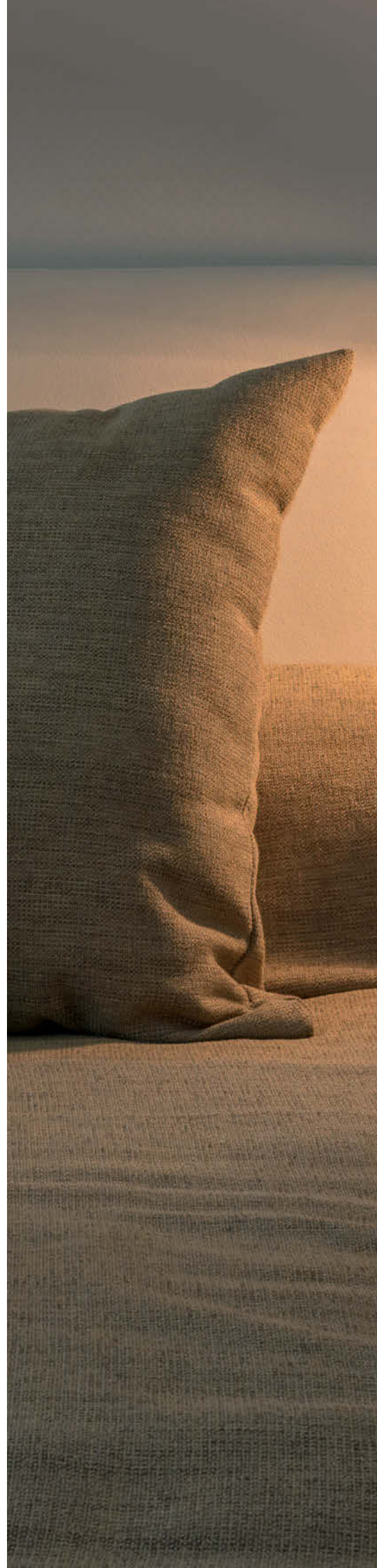



31



47

TAJO

Metall · metal ·
metale · metaal · metal · metallo ·
metal · metalli · metal · metal



17

01



↑ 73,5 cm, ↗ 51 cm
excl. 1 x E27, max. 40 W



5029010-01
5029010-17
5029010-47



01 weiß · white
17 mehrfarbig · multicolor
47 anthrazit · anthracite



47



01



17

PRONTO

Metall, Kunststoff · metal, plastic ·
 metale, plastique · metaal, kunststof · metal, plástico ·
 metallo, plastica · metal, plastic · metalli, muovi ·
 metal, plastik · metal, plastik



17



01



02



47

FLEXO

Metall, Kunststoff · metal, plastic ·
 metale, plastique · metaal, kunststof · metal, plástico ·
 metallo, plastica · metal, plastic · metalli, muovi ·
 metal, plastik · metal, plastik



↓ 30 cm, ↗ 22 cm
 excl. 1x E27, max. 18 W



5027011-01
 5027011-17
 5027011-47



↓ 30 cm, ↗ 30 cm
 excl. 1x E14, max. 18 W



5028010-01
 5028010-02
 5028010-17
 5028010-47



01 weiß · white
 02 schwarz · black
 17 mehrfarbig · multicolor
 47 silberfarbig · silver-coloured



07

DONNA

Metall, Glas alabasterfarbig ·
 metal, alabaster-coloured glass ·
 metale, verre couleur albâtre ·
 metaal, albastkleurig glas ·
 metal, vidrio de color alabastro ·
 metallo, vetro colore alabastro ·
 metal, sticla culoare alabastro ·
 metalli, lasi alabasteri väri ·
 metal, szkło alabaster kolor ·
 metal, cam kaymaktaşı rengi



08



32

EMERALD

Metall, Glas matt · metal, mat glass ·
 metale, verre mat · metaal, mat glas ·
 metal, vidrio mate · metallo, vetro sabbiato ·
 metal, sticla mata · metalli, mattalasi ·
 metal, szkło matowane · metal, mat cam



06



07



↑ 30 cm, Ø 22,5 cm
 incl. 1 x SMD-LED, 4 W
 350 lm, 3.000 K



525790107
 525790108
 525790132



↑ 29 cm, Ø 15 cm
 incl. 1 x SMD-LED, 4 W
 350 lm, 3.000 K



525490106
 525490107



06 chrom · chrome
 07 Nickel matt · nickel mat
 08 Messing matt · brass mat
 32 schwarz matt · black mat

BERLIN

Metall, Glas matt · metal, mat glass ·
metale, verre mat · metaal, mat glas ·
metal, vidrio mate · metallo, vetro sabbiato ·
metal, sticla mata · metalli, mattalasi ·
metal, szkło matowane · metal, mat cam



79



07

535



↑ 39 cm, Ø 19,5 cm
incl. 1 x SMD-LED, 4 W
350 lm, 3.000 K

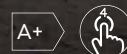

527590107
527590179



07 Nickel matt · nickel mat
79 goldfarbig · gold



00



07

CRISTO

chrom oder Nickel matt, Glas · chrome or nickel mat, glass ·
 chrome ou nickel mat, verre · chroom of nikkel mat, glas ·
 cromo o níquel mate, vidrio · cromo o nichel opaco, vetro ·
 crom sau nichel mat, sticla · kromi tai harjattu teräs, lasi ·
 chrom lub nikiel mat, szkło · krom veya mat nikel, cam



MONTI

Metall, Glas · metal, glass ·
 metale, verre · metaal, glas ·
 metal, vidrio · metallo, vetro ·
 metal, sticla · metalli, lasi ·
 metal, szkło · metal, cam



07



MORTEN

Metall, Glas alabasterfarbig · metal, alabaster-coloured glass ·
 metale, verre couleur albâtre · metaal, albastkleurig glas ·
 metal, vidrio de color alabastro · metallo, vetro colore alabastro ·
 metal, sticla culoare alabastru · metalli, lasi alabasteri väri ·
 metal, szkło alabaster kolor · metal, cam kaymaktaşı rengi



↑ 15 cm, Ø 11 cm
 incl. 1 x SMD-LED, 4,5 W
 400 lm, 3.000 K



529690100
 529690107



↑ 25,5 cm, Ø 15 cm
 incl. 1 x LED E14, 4 W
 320 lm, 3.000 K



529310107



↔ 15 x 8 cm, ↑ 18,5 cm
 excl. 1 x G9, max. 8 W



592000107



00 transparent · transparent
 07 Nickel matt · nickel mat



VENTURA

Metall, Glas matt · metal, mat glass ·
 metale, verre mat · metaal, mat glas · metal, vidrio mate ·
 metallo, vetro sabbiato · metal, sticla mata · metalli, mattalasi ·
 metal, szkło matowane · metal, mat cam



↑ 28 cm, Ø 15,5 cm
 incl. 1 x SMD-LED, 5 W
 400 lm, 3.000 K



529990103
 529990106
 529990107



03 Messing poliert · polished brass
06 chrom · chrome
07 Nickel matt · nickel matt



HENK

Metall, Glas alabasterfarbig ·
 metal, alabaster-coloured glass ·
 metale, verre couleur albâtre ·
 metaal, albastkleurig glas ·
 metal, vidrio de color alabastro ·
 metallo, vetro colore alabastro ·
 metal, sticla culoare alabastru ·
 metalli, lasi alabasteri väri ·
 metal, szkło alabaster kolor ·
 metal, cam kaymaktaşı rengi



GERRIT

Metall, Glas alabasterfarbig ·
 metal, alabaster-coloured glass ·
 metale, verre couleur albâtre ·
 metaal, albastkleurig glas ·
 metal, vidrio de color alabastro ·
 metallo, vetro colore alabastro ·
 metal, sticla culoare alabastru ·
 metalli, lasi alabasteri väri ·
 metal, szkło alabaster kolor ·
 metal, cam kaymaktaşı rengi



↓ 38 cm, Ø 26 cm
 excl. 1 x E14, max. 40 W



5925011-07
 5925011-08



↓ 25 cm, Ø 15 cm
 excl. 1 x E14, max. 40 W



5930011-01
 5930011-24

01 weiß · white
 07 Nickel matt · nickel mat
 08 Messing matt · brass mat
 24 rostfarbig · rusty



JOOST

Nickel matt, Glas matt · nickel mat, mat glass ·
 nickel mat, verre mat · nikkell mat, mat glas ·
 níquel mate, vidrio mate · nichel opaco, vetro sabbiato ·
 nichel mat, sticla mata · harjattu teräs, mattalasi ·
 nikiel mat, szkło matowane · mat nikel, mat cam

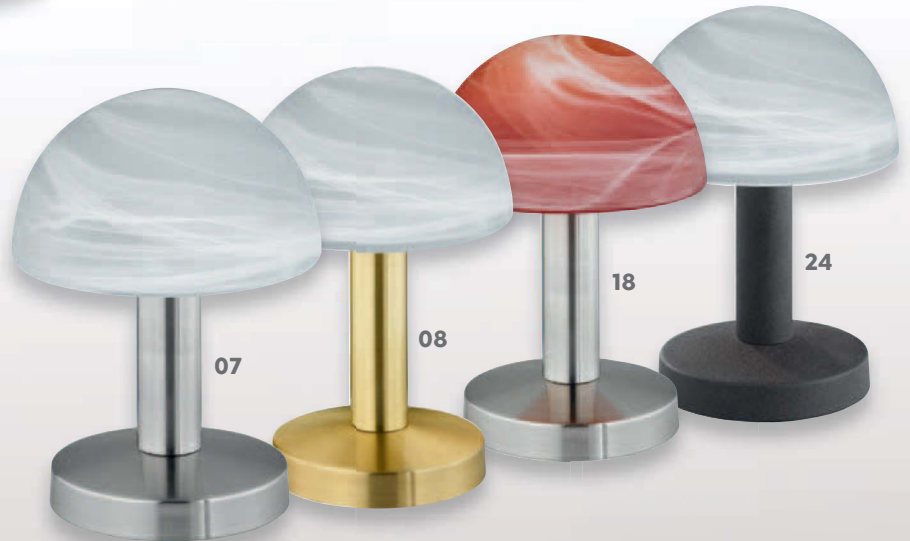

FYNN

Metall, Glas alabasterfarbig · metal, alabaster-coloured glass ·
 metale, verre couleur albâtre · metaal, albastkleurig glas ·
 metal, vidrio de color alabastro · metallo, vetro colore alabastro ·
 metal, sticla culoare alabastru · metalli, lasi alabasteri väri ·
 metal, szkło alabaster kolor · metal, cam kaymaktaş ı rengi



↓ 39 cm, Ø 19 cm
 excl. 1 x E27, max. 60 W



5922011-07



↓ 21 cm, Ø 15 cm
 excl. 1 x E14, max. 40 W



599000106
 599000107
 599000108
 599000118
 599000124



06 chrom · chrome
 07 Nickel matt · nickel mat
 08 Messing matt · brass mat
 18 orange · orange
 24 rostfarbig · rusty



DAVI

Nickel matt, Glas matt · nickel mat, mat glass ·
 nickel mat, verre mat · nikkell mat, mat glas ·
 níquel mate, vidrio mate · nichel opaco, vetro sabbiato ·
 nichel mat, sticla mata · harjattu teräs, mattalasi ·
 nikiel mat, szkło matowane · mat nikel, mat cam



SETA

Nickel matt, Glas · nickel mat, glass ·
 nickel mat, verre · nikkell mat, glas ·
 níquel mate, vidrio · nichel opaco, vetro ·
 nichel mat, sticla · harjattu teräs, lasi ·
 nikiel mat, szkło · mat nikel, cam



TILL

Nickel matt, Glas matt · nickel mat, mat glass ·
 nickel mat, verre mat · nikkell mat, mat glas ·
 níquel mate, vidrio mate · nichel opaco, vetro sabbiato ·
 nichel mat, sticla mata · harjattu teräs, mattalasi ·
 nikiel mat, szkło matowane · mat nikel, mat cam



ARY

Nickel matt, Glas matt · nickel mat, mat glass ·
 nickel mat, verre mat · nikkell mat, mat glas ·
 níquel mate, vidrio mate · nichel opaco, vetro sabbiato ·
 nichel mat, sticla mata · harjattu teräs, mattalasi ·
 nikiel mat, szkło matowane · mat nikel, mat cam



↓ 21 cm, Ø 8,5 cm
 incl. 1 x LED E14, 4 W
 320 lm, 3.000 K

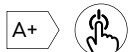

574090107



↓ 15 cm, ↔ 10 x 15 cm
 excl. 1 x E14, max. 40 W



5901011-07



↓ 16 cm, ↔ 10 x 15 cm
 excl. 1 x E14, max. 40 W



5900011-07



↓ 15 cm, Ø 9 cm
 excl. 1 x E14, max. 40 W



5908011-07

LACAN

chrom, Acryl · chrome, acryl ·
 chrome, acryl · chroom, acryl · cromo, acrílico ·
 cromo, acrilico · crom, acrilic · kromi, akryyli ·
 chrom, akryl · krom, akrilik



00



07



08

06

LUIS

Metall, Glas alabasterfarbig ·
 metal, alabaster-coloured glass ·
 metale, verre couleur albâtre ·
 metaal, albastkleurig glas ·
 metal, vidrio de color alabastro ·
 metallo, vetro colore alabastro ·
 metal, sticla culoare alabastru ·
 metalli, lasi alabasteri väri ·
 metal, szkło alabaster kolor ·
 metal, cam kaymaktaş ı rengi



↑ 30 cm, Ø 13 cm
 excl. 1 x E14, max. 40 W



593900100



↑ 32 cm, Ø 12
 excl. 1 x E14, max. 40 W



595500106
 595500107
 595500108



00 transparent · transparent
 06 chrom · chrome
 07 Nickel matt · nickel mat
 08 Messing matt · brass mat



01

02

DAYTONA

Marmor, Stoffschirm · marble, fabric shade ·
 marbre, abat-jour tissu · marmer, Stoffen kap ·
 mármol, Pantalla de tela · marmo, paralume in tessuto ·
 marmura, abajur textil · marmori, kangas varjostin ·
 marmur, Klosz z materiału · mermer, Kumaş şapka

542



↓ 27 cm, ↔ 16 x 16 cm
 excl. 1 x E14, max. 40 W



504000101
 504000102



↓ 27 cm, Ø 18 cm
 excl. 1 x E14, max. 40 W



503900101
 503900102



01 weiß · white
 02 schwarz · black

Leuchten aus echtem Marmor bestechen durch die natürliche und einzigartige Maserung, die jede Leuchte zu einem Unikat macht ·

Luminaires made of real marble impress with their natural and unique pattern, which makes every lamp to one of a kind ·

Luminaire en marbre véritable. Le grain naturel qui les constitue donne à chaque lampe une apparence propre et rend chaque modèle unique ·

Armaturen gemaakt van echt marmer hebben een eigen natuurlijke tekening, die elke lamp uniek maakt ·

Las luminarias de mármol genuino impresionan por su veta natural y única que hace que cada lámpara sea diferente ·

Gli apparecchi, realizzati in marmo, colpiscono con il loro grano naturale, che rende ogni lampada unica ·

Corpurile de iluminat facute din marmura adevărată impresionează cu granulația lor unică și naturală, care face din fiecare lampă un unicat ·

Valaisimet jotka on tehty oikeasta marmorista tekevät vaikutuksen niiden luonnollisella ja yksilöllisellä kuvioinnilla joka tekee jokaisesta kappaleesta yksilöllisen sekä ainutlaatuisen ·

Oprawy wykonane z prawdziwego marmuru zachwyca naturalny i niepowtarzalny mazerunek, który sprawia, że każda lampa jest jedyna w swoim rodzaju ·

Her bir ürünü eşsiz kılan doğal dokusuyla etkileyici gerçek mermerden yapılmış aydınlatma ürünleri.

ORLANDO

Marmor, Stoffschirm · marble, fabric shade ·
marbre, abat-jour tissu · marmer, Stoffen kap ·
mármol, Pantalla de tela · marmo, paralume in tessuto ·
marmura, abajur textil · marmori, kangas varjostin ·
marmur, Klosz z materiału · mermer, Kumaş şapka





MATS

Nickel matt, Stoff · nickel mat, fabric ·
 nickel mat, tissu · nikkell mat, textiel · níquel mate, tela ·
 nichel opaco, tessuto · nichel mat, textil · harjattu teräs, tekstiili ·
 nikiel mat, tkanina · mat nikel, kumaş



↑ 24 cm, Ø 14 cm
 excl. 1 x E14, max. 40 W

A++ - E



599600101
 599600102
 599600115
 599600119
 599600142

01 weiß · white
02 schwarz · black
15 grün · green
19 türkis · turquoise
42 anthrazit · anthacite





02

01

PIET

Nickel matt, Stoff · nickel mat, fabric ·
 nickel mat, tissu · nikkell mat, textiel ·
 níquel mate, tela · nichel opaco, tessuto ·
 nichel mat, textil · harjattu teräs, tekstiili ·
 nikiel mat, tkanina · mat nikel, kumaş



42



WIM

chrom, Stoff · chrome, fabric ·
 chrome, tissu · chroom, textiel · cromo, tela ·
 cromo, tessuto · crom, textil · kromi, tekstiili ·
 chrom, tkanina · krom, kumaş



↓ 30 cm, Ø 15,5 cm
 excl. 1 x E14, max. 40 W



5960011-01



↓ 35,5 cm, ↔ 12 x 12 cm
 excl. 1 x E14, max. 40 W



5914011-01
 5914011-02
 5914011-42



01 weiß · white
02 schwarz · black
42 anthrazit · anthracite





Spotserien

Spots
Spotterie
Spots
Focos
Faretti
Spoturi
Spotit
Reflektorki
Spotlar

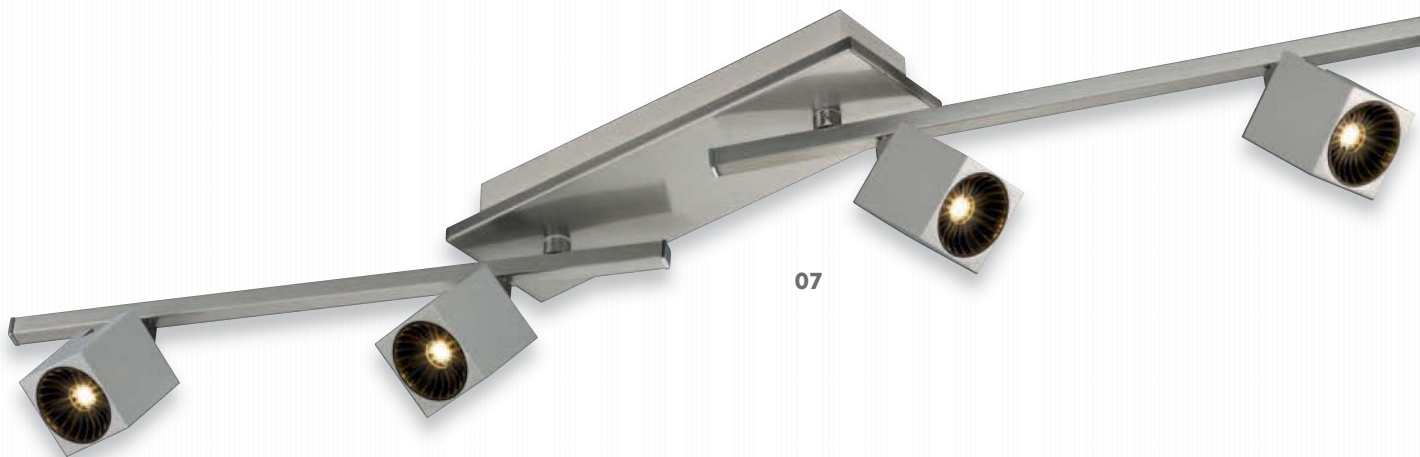

07

CUBA

Nickel matt oder weiß matt · nickel mat or white mat ·
 nickel mat ou blanc mat · nikkell mat of wit mat ·
 níquel mate o estera blanca · nichel opaco o bianco opaco ·
 nichel mat sau alb mat · harjattu teräs tai valkoinen matto ·
 nikiel mat lub biały mat · mat nikel veya beyaz mat

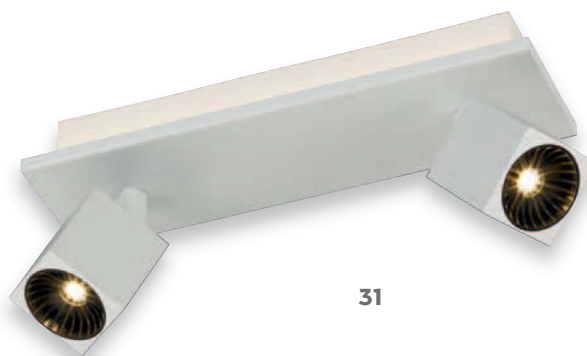

31



1x

2x

3x



Getrennt schaltbar · Separately switchable
 Interrupteurs séparés · Gescheiden schakelbaar ·
 Interruptores separados · Interruttori separati ·
 Intreruptoare separate · Erikseen kytkettävissä ·
 Oddzileny przełącznik · Dışarıdan anahtarlı



↔ 10 x 15 cm, ↗ 15 cm
 incl. 1 x SMD-LED, 4,3 W
 430 lm, 3.000 K
 incl. 1 x SMD, 3 W
 280 lm, 3.000 K



828570207
 828570231

↔ 30 x 8,5 cm, ↑ 14 cm
 incl. 2 x SMD-LED, 4,3 W
 2 x 430 lm, 3.000 K
 incl. 1 x SMD, 4 W
 330 lm, 3.000 K



828510307
 828510331

↔ 55 x 8,5 cm, ↑ 15,5 cm
 incl. 3 x SMD-LED, 4,3 W
 3 x 430 lm, 3.000 K
 incl. 1 x SMD, 8 W
 640 lm, 3.000 K



828510407
 828510431

↔ 86 x 8,5 cm, ↑ 18 cm
 incl. 4 x SMD-LED, 4,3 W
 4 x 430 lm, 3.000 K
 incl. 1 x SMD, 8 W
 640 lm, 3.000 K



828510507
 828510531

↔ 28 x 28 cm, ↑ 14 cm
 incl. 4 x SMD-LED, 4,3 W
 4 x 430 lm, 3.000 K
 incl. 1 x SMD, 8 W
 640 lm, 3.000 K



828530507
 828530531



07 Nickel matt · nickel mat
31 weiß matt · white mat



↑ 11 x 11 cm, ↗ 16 cm
incl. 1 x SMD, 8 W
730 lm, 3.000 K



827890131
827890132

↔ 30 x 9 cm, ↗ 16 cm
incl. 2 x SMD, 6 W
2 x 550 lm, 3.000 K



827890231
827890232

↔ 45 x 9 cm, ↗ 16 cm
incl. 3 x SMD, 6 W
3 x 550 lm, 3.000 K



827890331
827890332

↔ 26 x 25 cm, ↑ 16 cm
incl. 4 x SMD, 6 W
4 x 550 lm, 3.000 K

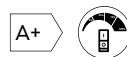

827830431
827830432

↓ 154 cm, ↔ 28 cm
incl. 3 x SMD, 4,7 W
3 x 470 lm, 3.000 K

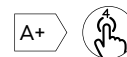

427890331
427890332

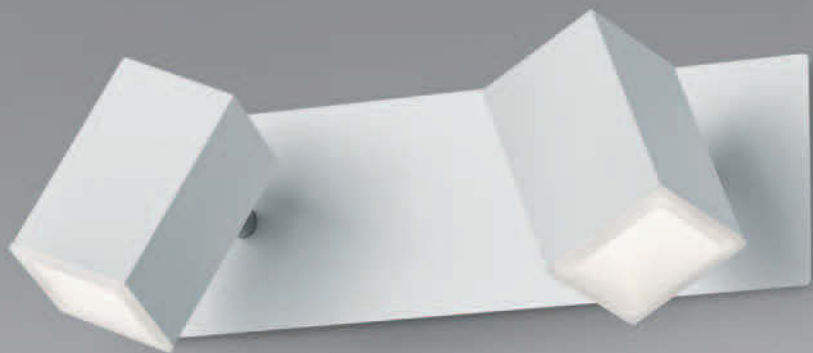

LAGOS

Metall, Acryl · metal, acryl ·
metale, acryl · metaal, acryl · metal, acrílico ·
metallo, acrilico · metal, acrilic · metalli, akryyli ·
metal, akryl · metal, akrilik

LED SWITCHDIMMER



31 weiß matt · white mat

32 schwarz matt · black mat



DUKE

Nickel matt, chrom · nickel mat, chrome ·
 nickel mat, chrome · nikkell mat, chrom · níquel mate, cromo ·
 nichel opaco, cromo · nichel mat, crom · harjattu teräs, kromi ·
 nikiel mat, chrom · mat nikel, krom

552



Ø 16 cm,, ↗ 15 cm
 incl. 1 x SMD-LED, 4,3 W
 400 lm, 3.000 K



872170107



↔ 36,5 cm, ↑ 18 cm
 incl. 2 x SMD-LED, 4,3 W
 2 x 400 lm, 3.000 K



872110207



↔ 52,5 cm, ↑ 18 cm
 incl. 3 x SMD-LED, 4,3 W
 3 x 400 lm, 3.000 K



872110307



↔ 83 cm, ↑ 18 cm
 incl. 4 x SMD-LED, 4,3 W
 4 x 400 lm, 3.000 K



872110407



↔ 90 cm, ↑ 95 - 150 cm
 incl. 5 x SMD-LED, 4,3 W
 5 x 400 lm, 3.000 K



372110507



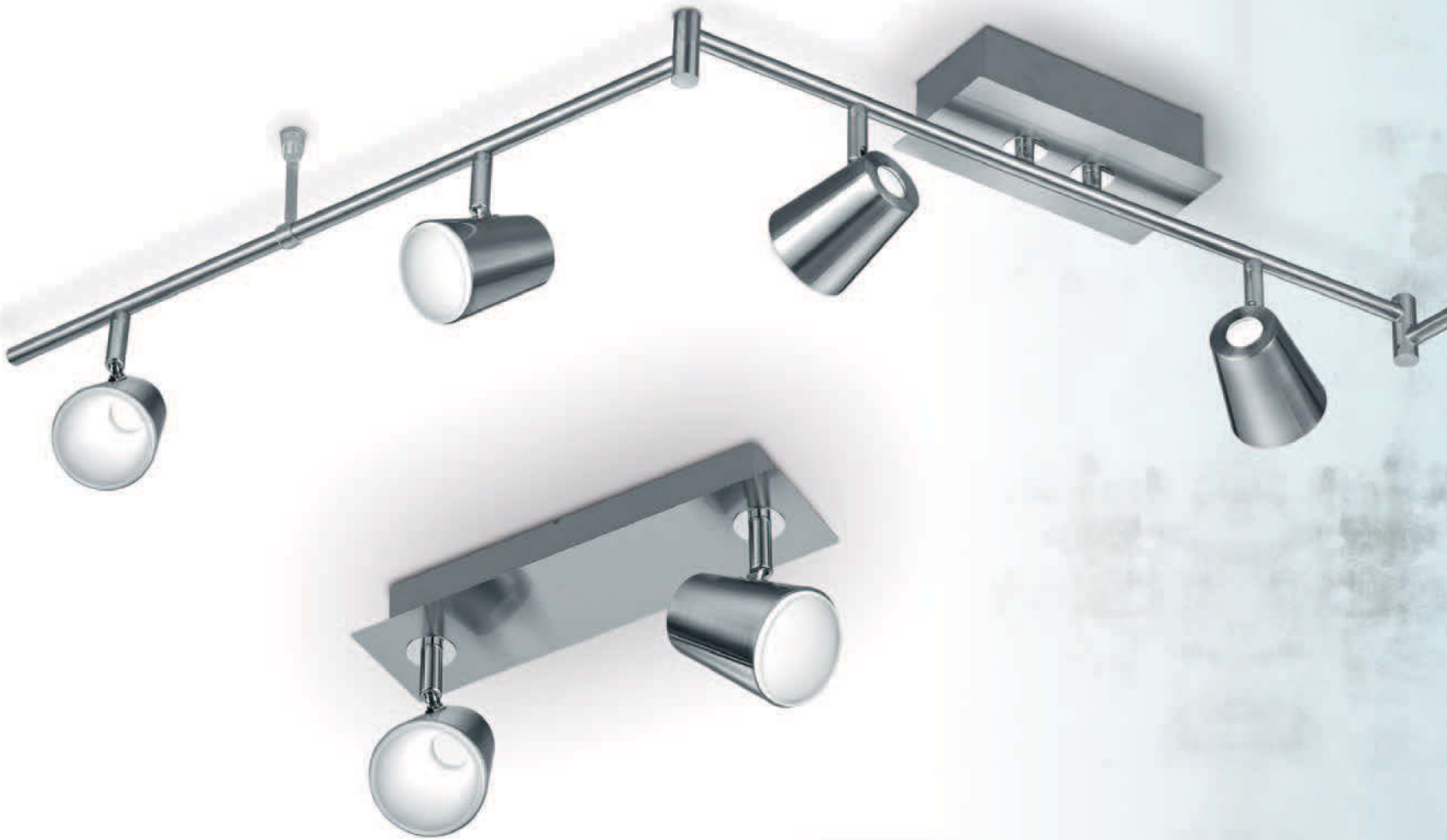

NARCOS

Nickel matt · nickel mat ·
 nickel mat · nikkel mat · níquel mate · nichel opaco ·
 nichel mat · harjattu teräs · nikiel mat · mat nikel



↓ 12 x 7,5 cm, ↗ 16 cm
 incl. SMD-LED, 6 W
 550 lm, 3.000 K



873170107



↔ 28,5 x 9,5 cm, ↗ 16 cm
 incl. 2 x SMD-LED, 6 W
 2 x 550 lm, 3.000 K



873170207



↔ 45 x 9,5 cm, ↓ 16 cm
 incl. 3 x SMD-LED, 6 W
 3 x 550 lm, 3.000 K



873110307



↔ 81,5 x 8 cm, ↓ 20 cm
 incl. 4 x SMD-LED, 6 W
 4 x 550 lm, 3.000 K

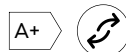

873110407



↔ 177 x 10 cm, ↓ 23 cm
 incl. 6 x SMD-LED, 6 W
 6 x 550 lm, 3.000 K



873110607

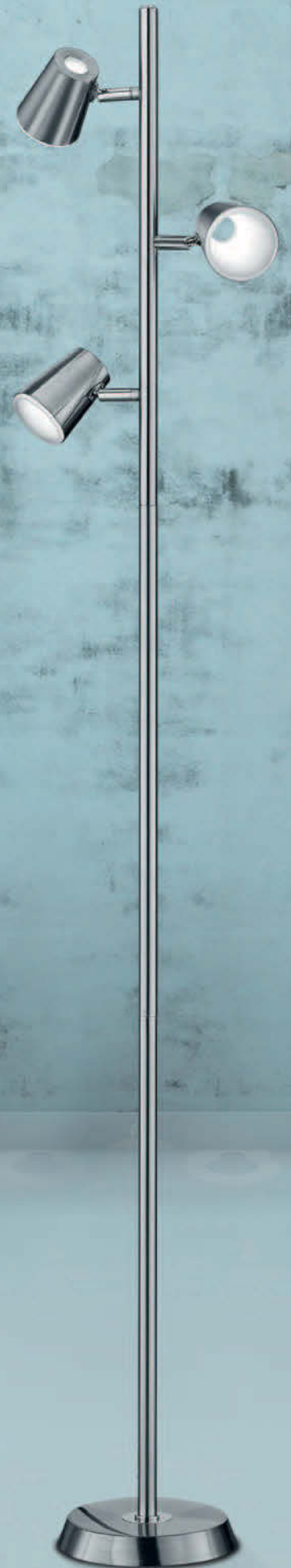
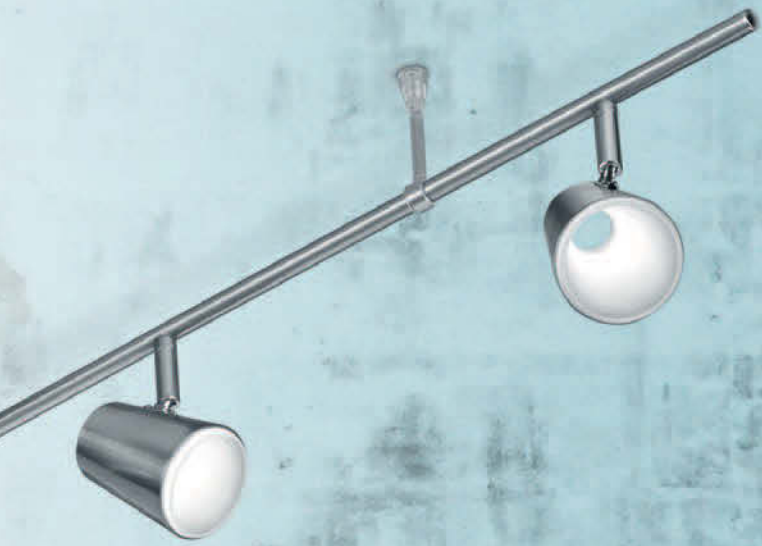

↑ 38 cm, ↗ 23 cm
incl. SMD-LED, 4,7 W
470 lm, 3.000 K



573190107



↑ 154 cm, ↔ 28 cm
incl. 3 x SMD-LED, 4,7 W
3 x 470 lm, 3.000 K



473190307



NARCOS

weiß matt · white mat ·
blanc mat · wit mat · blanco mate · bianco opaco ·
alb mat · valkoinen teräs · biały mat · mat beyaz



↓ 12 x 7,5 cm, ↗ 16 cm
incl. SMD-LED, 6 W
550 lm, 3.000 K



873170131



↔ 28,5 x 9,5 cm, ↗ 16 cm
incl. 2 x SMD-LED, 6 W
2 x 550 lm, 3.000 K



873170231



↔ 45 x 9,5 cm, ↓ 16 cm
incl. 3 x SMD-LED, 6 W
3 x 550 lm, 3.000 K



873110331

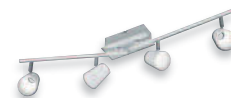

↔ 81,5 x 8 cm, ↓ 20 cm
incl. 4 x SMD-LED, 6 W
4 x 550 lm, 3.000 K



873110431



↔ 177 x 10 cm, ↓ 23 cm
incl. 6 x SMD-LED, 6 W
6 x 550 lm, 3.000 K



873110631



↑ 154 cm, ↔ 28 cm
incl. 3 x SMD-LED, 4,7 W
3 x 470 lm, 3.000 K



473190331



↑ 38 cm, ↗ 23 cm
incl. SMD-LED, 4,7 W
470 lm, 3.000 K



573190131



CLAPTON

Aluminium gebürstet, chrom, Glas weiß gewischt ·
 brushed aluminium, chrome, glass white brushed glass ·
 aluminium balayé, chrome, verre blanc balayé ·
 geborsteld aluminium, chroom, wit geborsteld glas ·
 aluminio pulido, cromo, blanco pulido · alluminio
 spazzolato, cromo, vetro bianco spazzolato · aluminiu
 lucios, crom, alb lucios · harjattu alumiini, kromi,
 lasi harjattu valkoinen · aluminium szczotkowane, chrom,
 szkło białe otarła · alüminyum, krom, beyaz cam



558



↑ 20 x 7 cm, ↗ 16 cm
 incl. 1 x SMD-LED, 4,5 W
 400 lm, 3.000 K



821470105



↔ 36 x 7 cm, ↑ 18,5 cm
 incl. 2 x SMD-LED, 4,5 W
 2 x 400 lm, 3.000 K

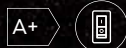

821470205



↔ 50 x 7 cm, ↑ 18,5 cm
 incl. 3 x SMD-LED, 4,5 W
 3 x 400 lm, 3.000 K



821410305



↔ 96,5 x 8 cm, ↑ 18,5 cm
 incl. 4 x SMD-LED, 4,5 W
 4 x 400 lm, 3.000 K



821410405



↔ max.150 x 8 cm, ↑ 24 cm
 incl. 6 x SMD-LED, 4,5 W
 6 x 400 lm, 3.000 K



821410605



↔ 31 x 22 cm, ↑ 18,5 cm
incl. 4 x SMD-LED, 4,5 W
4 x 400 lm, 3.000 K

A+

821430405



↔ 70 x 50 cm, ↑ 23 cm
incl. 5 x SMD-LED, 4,5 W
5 x 400 lm, 3.000 K

A+

621410505



OPIUM

Nickel matt, chrom, Acryl · nickel mat, chrome, acryl ·
 nickel mat, chrome, acryl · nikkell mat, chroom, acryl ·
 níquel mate, cromo, acrílico · nichel opaco, cromo, acrílico ·
 nichel mat, crom, acrylic · harjattu teräs, kromi, akryyli ·
 nikiel mat, chrom, akryl · mat nikel, krom, akrilik



560



↔ 7 x 14,5 cm, ↗ 16 cm
 incl. 1 x SMD-LED, 4,5 W
 430 lm, 3.000 K



870670107

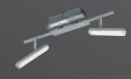

↔ 36 x 7 cm, ↑ 20 cm
 incl. 2 x SMD-LED, 4,5 W
 2 x 430 lm, 3.000 K



870610207



↔ 51 x 7 cm, ↑ 20 cm
 incl. 3 x SMD-LED, 4,5 W
 3 x 430 lm, 3.000 K



870610307



↔ 75 x 7 cm, ↑ 20 cm
 incl. 4 x SMD-LED, 4,5 W
 4 x 430 lm, 3.000 K



870610407





Ø 8 cm, √ 15 cm
incl. 1 x SMD-LED, 3,8 W
350 lm, 3.100 K



828210106



↔ 33 cm, ↓ 16,5 cm
incl. 2 x SMD-LED, 3,8 W
2 x 350 lm, 3.100 K



828210206



↔ 50 cm, ↓ 16,5 cm
incl. 3 x SMD-LED, 3,8 W
3 x 350 lm, 3.100 K



828210306



↔ 83 cm, ↓ 16,5 cm
incl. 4 x SMD-LED, 3,8 W
4 x 350 lm, 3.100 K



828210406



↔ 180 cm, ↓ 19 cm
incl. 6 x SMD-LED, 3,8 W
6 x 350 lm, 3.100 K



828210606



↔ 75 x 45 cm, ↓ 25 cm
incl. 5 x SMD-LED, 3,8 W
5 x 350 lm, 3.100 K



628290506



BALOUBET

chrom, Kunststoff/Metall · chrome, plastic/metal ·
 chrome, plastique/metale · chrom, kunststof/metaal ·
 cromo, plástico/metal · cromo, plastica/metallo ·
 crom, plastic/metal · kromi, muovi/metalli ·
 chrom, plastik/metal · krom, plastik/metal



↔ 75 cm, ↑ 79 - 180 cm
 incl. 4 x SMD-LED, 3,8 W
 4 x 350 lm, 3.100 K

↑ 35 cm, ↗ 22 cm
 incl. 1 x SMD-LED, 3,8 W
 350 lm, 3.100 K

↓ max. 44 cm
 incl. 1 x SMD-LED, 3,8 W
 350 lm, 3.100 K

↑ 125 cm, ↗ 45 cm
 incl. 1 x SMD-LED, 3,8 W
 350 lm, 3.100 K

↑ 125 cm, ↗ 45 cm
 incl. 2 x SMD-LED, 3,8 W
 2 x 350 lm, 3.100 K

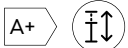

328210406



528210106



828280106



428210106



428210206



SHARK

Nickel matt, Acryl · nickel mat, acryl ·
 nickel mat, acryl · nikkell mat, acryl · níquel mate, acrílico · nichel opaco, acrilico ·
 nichel mat, acrilic · harjattu teräs, akryyli · nikiel mat, akryl · mat nikel, akrilik



↔ 8,2 x 8,5 cm, ↗ 13 cm
 incl. 1 x SMD-LED, 3,5 W
 340 lm, 3.000 K



879310107



↔ 34 cm, ↑ 16 cm
 incl. 2 x SMD-LED, 3,5 W
 2 x 340 lm, 3.000 K



879310207



Ø 25 cm, ↑ 15,5 cm
 incl. 3 x SMD-LED, 3,5 W
 3 x 340 lm, 3.000 K



879390307



↔ 72 cm, ↑ 15,5 cm
 incl. 4 x SMD-LED, 3,5 W
 4 x 340 lm, 3.000 K



879310407



↔ 80,5 cm, ↑ 17,5 cm
 incl. 6 x SMD-LED, 3,5 W
 6 x 340 lm, 3.000 K



879310607



↑ 40 cm
incl. 2 x SMD-LED, 3,5 W
2 x 340 lm, 3.000 K



579310207



↑ 150 cm
incl. 3 x SMD-LED, 3,5 W
3 x 340 lm, 3.000 K

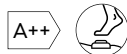

479310307



566

AVIGNON

chrom, Acryl · chrome, acryl ·
chrome, acryl · chroom, acryl · cromo, acrílico ·
cromo, acrilico · crom, acrilic · kromi, akryyli ·
chrom, akryl · krom, akrilik

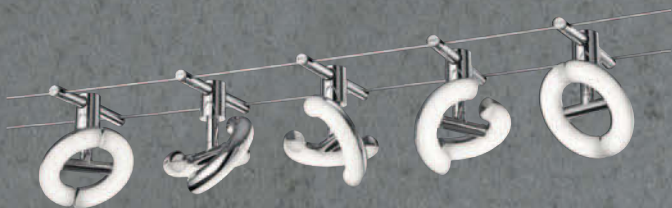

↔ max. 500 x 13 cm
incl. 5 x SMD-LED, 4,1 W
5 x 330 lm, 3.000 K

A+

777710506



RENNES

chrom, Acryl · chrome, acryl ·
 chrome, acryl · chroom, acryl · cromo, acrílico ·
 cromo, acrílico · crom, acrilic · kromi, akryyli ·
 chrom, akryl · krom, akrilik



BASIC

titanfarbig · titan ·
 titane · titaan · titán · titano ·
 titaniu · titaani · tytanowy · titan

incl. LED GU5,3/MR16, 3 W
 260 lm, 3.000 K
 25.000 h



A+

916-30



BALOUBET

chrom, Acryl · chrome, acryl ·
 chrome, acryl · chroom, acryl · cromo, acrílico ·
 cromo, acrílico · crom, acrilic · kromi, akryyli ·
 chrom, akryl · krom, akrilik



↔ max. 500 x 11 cm
 incl. 5 x SMD-LED, 3,8 W
 5 x 350 lm, 3.000 K

A+

774110506



↔ max. 500 x 8 cm
 incl. 5 x LED GU5,3/MR16, 3 W
 5 x 260 lm, 3.000 K

A+

770010587



↔ max. 500 x 11 cm
 incl. 5 x SMD-LED, 3,8 W
 5 x 350 lm, 3.100 K

A+

778210506



PILATUS

chrom, Acryl · chrome, acryl ·
 chrome, acryl · chroom, acryl · cromo, acrílico · cromo, acrilico · crom, acrilic ·
 kromi, akryyli · chrom, akryl · krom, akrilik



SHARK

Nickel matt, Acryl · nickel mat, acryl ·
 nickel mat, acryl · nikkell mat, acryl · níquel mate, acrílico · nichel opaco, acrilico ·
 nichel mat, acrilic · harjattu teräs, akryyli · nikiel mat, akryl · mat nikel, akrilik



SHARK

Nickel matt, Acryl · nickel mat, acryl ·
 nickel mat, acryl · nikkell mat, acryl · níquel mate, acrílico · nichel opaco, acrilico ·
 nichel mat, acrilic · harjattu teräs, akryyli · nikiel mat, akryl · mat nikel, akrilik



↔ max. 500 x 13,5 cm
 incl. 5 x SMD-LED, 3,8 W
 5 x 350 lm, 3.000 K

↔ max. 500 x 13,5 cm
 incl. 5 x SMD-LED, 2,5 W
 5 x 245 lm, 3.000 K

↔ max. 750 x 13,5 cm
 incl. 7 x SMD-LED, 2,5 W
 7 x 245 lm, 3.000 K

A+

A++

A++

775910506

779310507

779310707





↔ 9 x 9 cm, ↗ 15 cm
excl. 1 x GU10, max. 35 W

↔ 24 x 7 cm, ↓ 15 cm
excl. 2 x GU10, max. 35 W

↔ 41 x 7 cm, ↓ 15 cm
excl. 3 x GU10, max. 35 W

↔ 24 x 24 cm, ↓ 15 cm
excl. 4 x GU10, max. 35 W

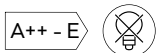
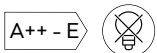
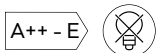
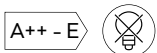

803500131
803500132

803500231
803500232

803500331
803500332

803590431
803590432

31 weiß matt · white mat
32 schwarz matt · black mat



PAGO

Metall, weiß matt oder schwarz matt · metal, white mat or black mat ·
metale, blanc mat ou noir mat · metaal, wit mat of mat zwart ·
metal, estera blanca o estera negra · metallo, bianco opaco o nero opaco ·
metal, alb mat sau negru mat · metalli, valkoinen matto tai musta matto ·
metal, biały mat lub czarny mat · metal, beyaz mat veya siyah mat

Empfohlen:

recommended: LED GU10, 5 W
400 lm, 3.000 K



A+



956-55



MARLEY

Metall, weiß oder schwarz matt · metal, white or black mat ·
 metale, blanc ou noir mat · metaal, wit of mat zwart · metal, blanco o estera negra ·
 metallo, bianco o nero opaco · metal, alb sau negru mat · metalli, valkoinen tai musta matto ·
 metal, biały lub czarny mat · metal, beyaz veya siyah mat

Empfohlen:
 recommended: LED GU10, 5 W
 400 lm, 3.000 K

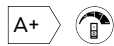

956-55



↓ 12 x 12 cm, ↗ 15 cm
 excl. 1 x GU10, max. 35 W

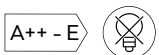

802400101
802400132



↔ 30 x 9 cm, ↓ 15 cm
 excl. 2 x GU10, max. 35 W

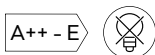

802400201
802400232



↔ 48 x 9 cm, ↓ 15 cm
 excl. 3 x GU10, max. 35 W

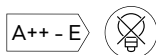

802400301
802400332



↔ 24 x 24 cm, ↓ 15 cm
 excl. 4 x GU10, max. 35 W

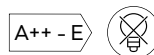

802430401
802430432



↓ 150 cm, ↔ 12 x 12 cm, Ø 6 cm
 excl. 1 x GU10, max. 35 W

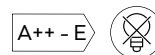

312400101
312400132



↔ 77,5 x 57,5 cm, ↑ 22,5 cm
excl. 5 x GU10, max. 35 W



612400501
612400532

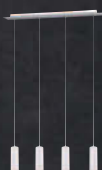

↔ 75 x 9 cm, ↑ 150 cm
excl. 4 x GU10, max. 35 W

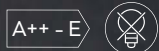

312400401
312400432



↑ 18 x 6 cm, ↗ 8 cm
excl. 2 x GU10, max. 35 W



212400201
212400232



573



01 weiß · white
32 schwarz matt · black mat



↓ 12 x 12 cm, ↗ 15 cm
excl. 1 x GU10, max. 35 W

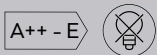

802400107
802400124



↓ 18 x 6 cm, ↗ 8 cm
excl. 2 x GU10, max. 35 W



212400207
212400224



↓ 150 cm, ↔ 12 x 12 cm, Ø 6 cm
excl. 1 x GU10, max. 35 W

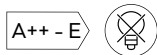

312400107
312400124



↔ 75 x 9 cm, ↓ 150 cm
excl. 4 x GU10, max. 35 W

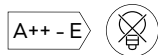

312400407
312400424



MARLEY

Metall, Nickel matt oder rostfarbig · metal, nickel mat or rusty ·
 metale, nickel mat ou rouille · metaal, nikkell mat of roestkleur · metal, níquel mate o óxido ·
 metallo, nichel opaco o ruggine · metal, nichel mat sau ruginiu · metalli, harjattu teräs tai rustiikki ·
 metal, nikiel mat lub miedz · metal, mat nikel veyá pas

Empfohlen:

recommended: LED GU10, 5 W
 400 lm, 3.000 K

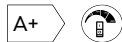

956-55



↔ 77,5 x 57,5 cm, ↓ 22,5 cm
 excl. 5 x GU10, max. 35 W



612400507
 612400524



↔ 30 x 9 cm, ↓ 15 cm
 excl. 2 x GU10, max. 35 W

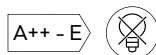

802400207
 802400224



↔ 48 x 9 cm, ↓ 15 cm
 excl. 3 x GU10, max. 35 W

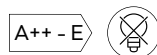

802400307
 802400324



↔ 24 x 24 cm, ↓ 15 cm
 excl. 4 x GU10, max. 35 W

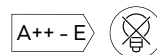

802430407
 802430424



07 Nickel matt · nickel mat
24 rostfarbig · rusty



↔ 10 x 10 cm, ↗ 14 cm
excl. 1 x GU10, max. 25 W

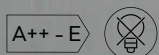

802600107



↔ 26 x 10 cm, ↓ 14 cm
excl. 2 x GU10, max. 25 W

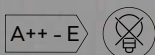

802600207



↔ 45 x 10 cm, ↓ 14 cm
excl. 3 x GU10, max. 25 W

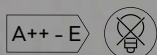

802600307



↔ 64 x 10 cm, ↓ 14 cm
excl. 4 x GU10, max. 25 W

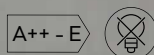

802600407



DAXTER

Nickel matt · nickel mat ·
nickel mat · nikkell mat · níquel mate · nichel opaco ·
nichel mat · harjattu teräs · nikiel mat · mat nikel

Empfohlen:

recommended: LED GU10, 5 W
400 lm, 3.000 K



956-55





↔ 10 x 15 cm, ↗ 18 cm
excl. 1 x GU10, max. 42 W

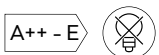

802500178



↔ 23 x 10 cm, ↑ 18 cm
excl. 2 x GU10, max. 42 W

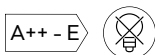

802500278



↔ 35 x 10 cm, ↑ 18 cm
excl. 3 x GU10, max. 42 W

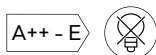

802500378



CONCRETE

Beton, grau · concrete, grey ·
béton, gris · beton, grijs · hormigón, gris · cemento, grigio · beton, gri · betoni,
harmaa · beton, popielaty · beton, gri

Empfohlen:
recommended: LED GU10, 5 W
400 lm, 3.000 K



956-55



↔ 23 x 23 cm, ↑ 18 cm
excl. 4 x GU10, max. 42 W

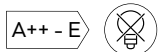

802530478



↑ 38 cm, ↔ 24 cm
excl. 1 x GU10, max. 42 W



512500178



↑ 160 cm, ↔ 34 cm
excl. 3 x GU10, max. 42 W



402500378



BOWIE

chrom · chrome ·
chrome · chroom · cromo ·
cromo · crom · kromi · chrom · krom

Empfohlen:
recommended: LED GU10, 3 W
250 lm, 3.000 K



A+

956-30



↓ 14 x 8 cm, ↗ 15 cm
excl. 1 x GU10, max. 25 W



818070106



↔ 40 x 8 cm, ↓ 18 cm
excl. 2 x GU10, max. 25 W

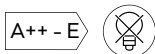

818000206



↔ 55 x 8 cm, ↓ 18 cm
excl. 3 x GU10, max. 25 W

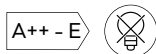

818000306





↓ 10,6 x 6 cm, ↗ 13 cm
excl. 1 x GU10, max. 28 W

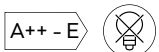

803000107



↓ 37 x 11 cm, ↗ 22 cm
excl. 1 x GU10, max. 28 W



803080107



↔ 32 x 5 cm, ↓ 13 cm
excl. 2 x GU10, max. 28 W

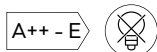

803000207



↔ 54 x 5 cm, ↓ 13 cm
excl. 3 x GU10, max. 28 W

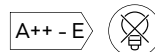

803000307



↔ 80 x 10 cm, ↓ 20 cm
excl. 4 x GU10, max. 28 W



803000407



MICHAEL

Nickel matt · nickel mat ·
 nickel mat · nikkell mat · níquel mate ·
 nichel opaco · nichel mat · harjattu teräs ·
 nikiel mat · mat nikel

Empfohlen:
 recommended: LED GU10, 5 W
 400 lm, 3.000 K



956-55



↔ 180 x 10 cm, ↓ 18 cm
 excl. 6 x GU10, max. 28 W

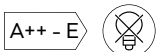

803000607



Ø 25,5 cm, ↓ 15 cm
 excl. 3 x GU10, max. 28 W

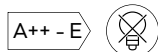

803090307

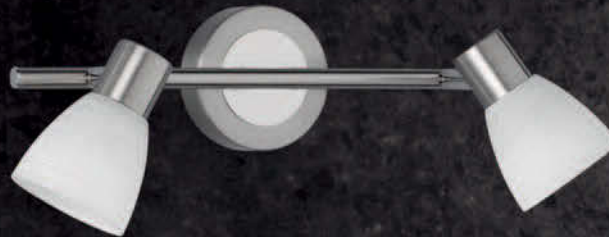

CARICO

Nickel matt, Glas weiß gewischt · nickel mat, glass white brushed glass ·
 nickel mat, verre blanc balayé · nikkell mat, wit geborsteld glas ·
 níquel mate, blanco pulido · nichel opaco, vetro bianco spazzolato ·
 nichel mat, alb lucios · harjattu teräs, lasi harjattu valkoinen ·
 nikiel mat, szkło białe otarła · mat nikel, beyaz cam



Ø 9 cm, ↗ 16 cm
 incl. 1 x LED G9, 3 W
 250 lm, 3.000 K



871570107



↔ 34 cm, ↑ 18 cm
 incl. 2 x LED G9, 3 W
 2 x 250 lm, 3.000 K



871510207



Ø 29,5 cm, ↑ 18 cm
 incl. 3 x LED G9, 3 W
 3 x 250 lm, 3.000 K



871590307



↔ 90 cm, ↑ 19 cm
 incl. 4 x LED G9, 3 W
 4 x 250 lm, 3.000 K



871510407



↔ 150 cm, ↑ 19 cm
 incl. 6 x LED G9, 3 W
 6 x 250 lm, 3.000 K



871510607



↔ 73 x 34,5 cm, ↓ 21,5 cm
incl. 5 x LED G9, 3 W
5 x 250 lm, 3.000 K



671510507



↔ 74,5 cm, ↓ 95 - 160 cm
incl. 4 x LED G9, 3 W
4 x 250 lm, 3.000 K



371510407



07

FREDDY

Nickel matt oder rostfarbig, Glas matt ·
 nickel mat or rusty, mat glass ·
 nickel mat ou rouille, verre mat · nikkell mat of roestkleur,
 mat glas · níquel mate o óxido, vidrio mate · nichel
 opaco o ruggine, vetro sabbaiato · nichel mat sau ruginiu,
 sticla mata · harjattu teräs tai rustiikki, mattalasi ·
 nikiel mat lub miedź, szkło matowane · mat nikel veyá pas,
 mat cam

incl.
 LED E14, 4 W
 320 lm, 3.000 K



A+

983-40



↓ 13 x 10 cm, ↗ 19 cm
 incl. 1 x LED E14, 4 W
 320 lm, 3.000 K



824810107
 824810128



↔ 30 cm, ↓ 20 cm
 incl. 2 x LED E14, 4 W
 2 x 320 lm, 3.000 K



824810207
 824810228



↔ 45 cm, ↓ 20,5 cm
 incl. 3 x LED E14, 4 W
 3 x 320 lm, 3.000 K



824810307
 824810328



↔ 60 cm, ↓ 20,5 cm
 incl. 4 x LED E14, 4 W
 4 x 320 lm, 3.000 K



824810407
 824810428



↔ 150 cm, ↓ 23 cm
 incl. 6 x LED E14, 4 W
 6 x 320 lm, 3.000 K



824810607
 824810628



Ø 52 cm, ↓ 19 cm
 incl. 3 x LED E14, 4 W
 3 x 320 lm, 3.000 K



624830307
 624830328



↓ 40 cm, ↗ 28 cm
incl. 1 x LED E14, 4 W
320 lm, 3.000 K



524810107
524810128



↓ 150 cm, ↗ 55 cm
incl. 1 x LED E14, 4 W
320 lm, 3.000 K



424810107
424810128



↓ 125 cm, ↗ 55 cm
incl. 2 x LED E14, 4 W
2 x 320 lm, 3.000 K



424810207
424810228



↔ 78 cm, ↑ 85 - 180 cm
incl. 4 x LED E14, 4 W
4 x 320 lm, 3.000 K



324810407
324810428



07 Nickel matt · nickel mat
28 rostfarbig antik · antique rust



LEVISTO

Nickel matt oder Messing matt, Glas alabasterfarbig ·
 nickel mat or brass mat, alabaster-coloured glass · nickel mat ou laiton
 mat, verre couleur albâtre · nikkell mat of messing mat, albastkleurig glas ·
 níquel mate o bronce mate, vidrio de color alabastro · nichel opaco o
 ottone satinato, vetro colore alabastro · nichel mat sau bronz mat, sticla
 culoare alabastru · harjattu teräs tai mattamessinki, lasi alabasteri väri ·
 nikiel mat lub mosiądz mat, szkło alabaster kolor · mat nikel veya mat pirinç,
 cam kaymaktaşı rengi

incl.
 LED E14, 5 W
 400 lm, 3.000 K



A+

983-60



Ø 10 cm, ↗ 19 cm
 incl. 1 x LED E14, 5 W
 400 lm, 3.000 K

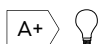

871010107
 871010108



↔ 33 cm, ↑ 19 cm
 incl. 2 x LED E14, 5 W
 2 x 400 lm, 3.000 K

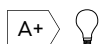

871010207
 871010208



↔ 55 cm, ↑ 19 cm
 incl. 3 x LED E14, 5 W
 3 x 400 lm, 3.000 K

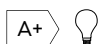

871010307
 871010308



Ø 30 cm, ↓ 21 cm
 incl. 3 x LED E14, 5 W
 3 x 400 lm, 3.000 K

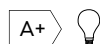

871090307
 871090308



↔ 88 cm, ↑ 19 cm
 incl. 4 x LED E14, 5 W
 4 x 400 lm, 3.000 K



871010407
 871010408



↔ 180 cm, ↑ 21 cm
incl. 6 x LED E14, 5 W
6 x 400 lm, 3.000 K

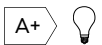

871010607
871010608



↔ 60,5 cm, ↓ 95 - 160 cm
incl. 3 x LED E14, 5 W
3 x 400 lm, 3.000 K



371010307
371010308



↔ 80,5 cm, ↓ 95 - 160 cm
incl. 4 x LED E14, 5 W
4 x 400 lm, 3.000 K



371010407
371010408



07 Nickel matt · nickel mat
08 Messing matt · brass mat

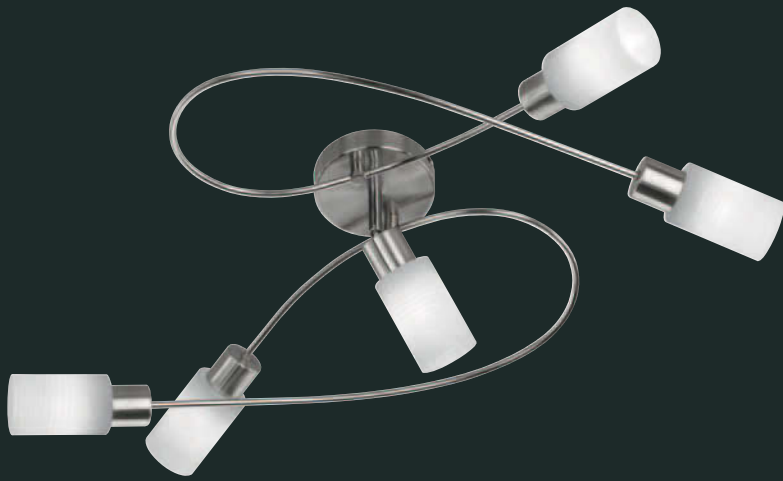

JONES

Nickel matt, Glas weiß gewischt · nickel mat, glass white brushed glass ·
 nickel mat, verre blanc balayé · nikkel mat, wit geborsteld glas ·
 níquel mate, blanco pulido · nichel opaco, vetro bianco spazzolato ·
 nichel mat, alb lucios · harjattu teräs, lasi harjattu valkoinen ·
 nikiel mat, szkło białe otarła · mat nikel, beyaz cam

incl.
 LED E14, 4 W
 320 lm, 3.000 K



A+

989-40

590



Ø 8 cm, ↗ 18 cm
 incl. 1 x LED E14, 4 W
 320 lm, 3.000 K



871410107



↔ 30 cm, ↑ 18 cm
 incl. 2 x LED E14, 4 W
 2 x 320 lm, 3.000 K



871410207



↔ 44 cm, ↑ 18 cm
 incl. 3 x LED E14, 4 W
 3 x 320 lm, 3.000 K



871410307



↔ 62 cm, ↑ 18 cm
 incl. 4 x LED E14, 4 W
 4 x 320 lm, 3.000 K



871410407



↔ 150 cm, ↑ 18 cm
 incl. 6 x LED E14, 4 W
 6 x 320 lm, 3.000 K



871410607



↔ 80 x 48 cm, ↑ 18 cm
incl. 5 x LED E14, 4 W
5 x 320 lm, 3.000 K

↔ 70 cm, ↑ 77 - 160 cm
incl. 4 x LED E14, 4 W
4 x 320 lm, 3.000 K



671410507



371410407



Empfohlen:
recommended: Filament-LED E27, 6 W
190 lm, 3.000 K



B

988-654



07



↔ 12 x 13 cm, ↗ 12,5 cm
excl. 1 x E27, max. 25 W



800570104
800570107



↔ 30 x 11,5 cm, ↓ 12,5 cm
excl. 2 x E27, max. 25 W



800570204
800570207



↔ 75 x 9 cm, ↓ 12,5 cm
excl. 4 x E27, max. 25 W

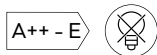

800500404
800500407



Ø 26 cm, ↓ 12,5 cm
excl. 3 x E27, max. 25 W

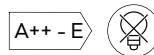

800590304
800590307



04 altmessing · old brass
07 Nickel matt · nickel mat



CARL

altmessing oder Nickel matt · old brass or nickel mat ·
laiton fumé ou nickel mat · oud brons of nikkel mat ·
bronce viejo o níquel mate · ottone invecchiato o nichel opaco ·
bronz antic sau nichel mat · antiikkimessinki tai harjattu teräs ·
patyna lub nikiel mat · antik piriç veya mat nikel

Empfohlen:

recommended: Filament-LED E27, 4 W
320 lm, 2.700 K



A+

904-479



↔ 9,5 x 12 cm, ↗ 17 cm
excl. 1 x E14, max. 40 W



800300132



↔ 36,5 cm, ↓ 19 cm
excl. 2 x E14, max. 40 W

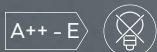

800300232



↔ 69,5 cm, ↓ 19 cm
excl. 4 x E14, max. 40 W



800300432



∅ 28,5 cm, ↓ 19 cm
excl. 3 x E14, max. 40 W



800300332



HOUSTON

Metall, schwarz/goldfarbig · metal, black/gold ·
metale, noir/ro · metaal, zwart/goud · metal, negro/oro ·
metallo, nero/oro · metal, negru/aur · metalli, musta/kultaa ·
metal, czarny/złota · metal, siyah/altın

Empfohlen:

recommended: Filament LED E14, 4 W
400 lm, 3.000 K



A++

989-400





Einbauleuchten

Recessed spots
Spots encastrés
Inbouwspots
Focos empotrables
Faretti incasso
Spoturi incastrate
Upotetut spotit
Oprawy wbudowane



1x

2x

3x



Getrennt schaltbar · Separately switchable
Interrupteurs séparés · Gescheiden schakelbaar ·
Interruptores separados · Interruttori separati ·
Intrerruptoare separate · Erikseen kytkettävissä ·
Oddzielny przełącznik · Dışarıdan anahtarlı